

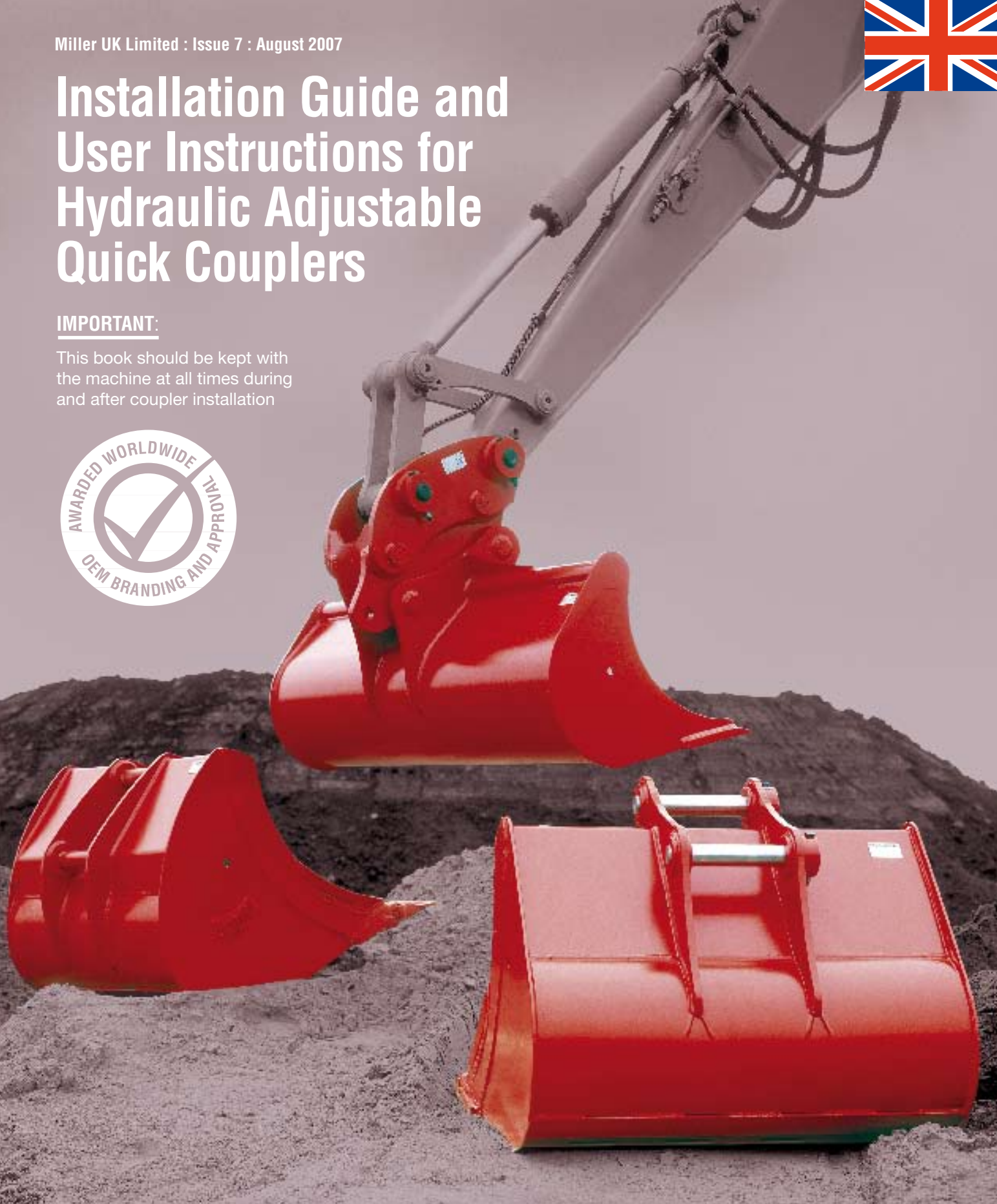

Installation Guide and User Instructions for Hydraulic Adjustable Quick Couplers

IMPORTANT:

This book should be kept with the machine at all times during and after coupler installation



The MPG Coupler [SAFETY PIN]



Thank you for purchasing
a Miller Coupler

The following information details
the installation procedure for your
Miller Quick Coupler.

Please take the time to read the instructions
carefully and carry out the installation in accordance with our
recommendations. This will enable you to benefit from the many
features incorporated within your Miller Coupler aimed at providing
you with increased versatility at the flick of a switch.

We trust that you will enjoy many trouble free years with your Miller
Coupler and hope that we may look forward to being of service to you
again soon.

Pioneering Attachment Changeover Technology.





Contents

SECTION 1 – PRODUCT INFORMATION	1
1.0 Miller Quick Couplers	2
1.1 The MPG Coupler	3

SECTION 2 – SAFETY	4
2.0 General Safety Information	5
2.1 In-Cab Decals	6
2.2 Bucket and Coupler Pin and Hydraulic Cylinder Weight Chart	7
2.3 Coupler Identification	7

SECTION 3 – INSTALLATION	8
3.0 Pre-installation Information	9
3.1 Installation Kit	9
3.2 Coupler Installation Procedure	10
3.3 Coupler Removal	14
3.4 Electrical and Hose Installation Diagrams	15

SECTION 4 – OPERATION	16
4.0 MPG Coupler Operation- attach & release	17
4.1 Lifting with the MPG Coupler	21
4.2 Using Demolition Attachments & Work Tools	21
4.3 Incorrect Coupler use	22

SECTION 5 – MAINTENANCE	23
5.0 MPG Coupler General Maintenance	24
5.1 MPG Coupler Daily Checks	24
5.2 MPG Coupler Weekly Checks	24
5.3 MPG Safety Pin Check	24
5.4 Torque Specifications	25
5.5 Trouble Shooter Guide	26
5.6 MPG Coupler Component Lists	27
5.7 MPG Hydraulic Cylinder – Removal/Replacement	28
5.8 Inspection & Repair of Coupler Frame	29

SECTION 6 – WARRANTY	30
-----------------------------	-----------



Installation Guide and User Instructions
for Hydraulic Adjustable Quick Couplers

PRODUCT INFORMATION

(1.0) MILLER QUICK COUPLERS

The Versatility of Miller Quick Couplers

Miller Quick Couplers are designed to facilitate the easy changeover of standard buckets and work tools. The couplers can operate with a range of buckets from a variety of machine manufacturers within the same tonnage range (fig 1.0). No modifications are required to the buckets or machine. The couplers can also utilise buckets in face mode position (fig 1.1), operate work tools and hydraulic breakers (fig 1.2) and operate as a lifting tool (fig 1.3).

If you are unsure which Miller coupler model you have, check the descriptions on page 3 to determine whether you have a Bug or an MPG, then make sure that you follow the correct installation and operation procedure for your specific coupler type.

Replacement Parts

Miller recommends that you fit genuine replacement parts. For advice or to order parts contact Miller on +44 (0)1670 707 272 or via info@miller-uk.com quoting the **coupler serial number** which can be found on the coupler data plate (section 2.3 page 7).

Coupler Installation and Operation

Miller offers a number of free services to ensure the correct installation and operation of the coupler. These include coupler inspection, installation training and operation guidance. Miller also offers a 'New for Old' scheme in which it buys back an old or alternative manufacturers coupler in part exchange for one of its universal designs.



fig 1.1
The coupler operating with a standard bucket in face mode



fig 1.2
The coupler operating with a hydraulic breaker

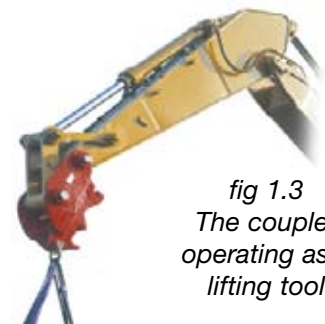

fig 1.3
The coupler operating as a lifting tool

(1.1) THE MPG COUPLER – HYDRAULIC

The hydraulic MPG has a hydraulic cylinder and a safety pin that needs to be manually inserted (fig 1.9). Depending on the model the MPG may have either 2 or 3 safety pin holes (fig 1.8).



The MPG coupler

fig 1.7



2 or 3 safety pin holes

fig 1.8

Hydraulic cylinder

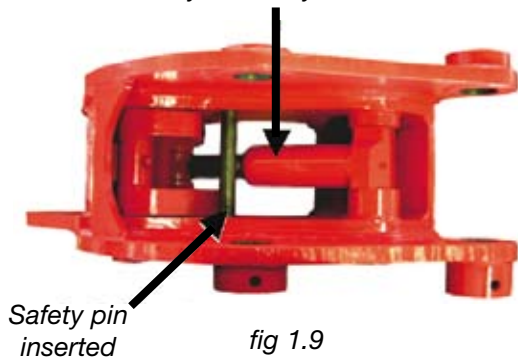

fig 1.9



Installation Guide and User Instructions for Hydraulic Adjustable Quick Couplers

SAFETY

(2.0) GENERAL SAFETY INFORMATION

Miller Couplers are designed to provide a safe and reliable solution for the easy changeover of **standard OEM buckets** and attachments for most popular machines in the same operating weight.

 **WARNING - Miller couplers must be installed and operated by appropriately trained and experienced personnel. Miller can provide an installation service and operator training if required. Please contact Miller and/or an authorised distributor for details.**

Miller cannot anticipate every possible circumstance that might involve a potential hazard. The warnings in this publication and on the product are, therefore, not all-inclusive. If a tool, procedure, work method or operating technique that is not specifically recommended by Miller is used; you must satisfy yourself that it is safe for you and for others. You should also ensure that the product will not be damaged or be made unsafe by the operation, lubrication, maintenance or repair procedures that you choose. It is the owner's and operator's responsibility therefore to ensure the coupler is in a good safe working condition.

 **WARNING IMPORTANT NOTICE -** This product may enable the operator to use buckets or attachments for which it is not specifically designed, i.e. oversized tools, buckets or equipment. You must always ensure that the operating capacity of the excavator is not exceeded as the excavator may become unstable and could be dangerous.

 **DANGER - Hydraulic Fluid** Never use your hands to search for hydraulic fluid leaks, use a piece of paper or cardboard. Escaping fluid under pressure can be invisible and can penetrate the skin and cause serious injury. If affected, see a doctor at once.

 **WARNING - Coupler Condition** A defective coupler could injure you or others. Do not operate a coupler that is defective.

 **WARNING - Decals** To ensure the safe operation of the quick coupler you must place the coupler decal in the machine cab where it can be seen clearly. Replace unreadable or missing decals with new ones before operating the machine.

 **WARNING - Modification and Welding** Non-approved modifications can cause injury and damage, making your coupler unsafe. Please call Miller for advice and service requirements.

 **WARNING - Protective Clothing** Oil resistant safety gloves must be worn during installation and dismantling. Field Service personnel and operators must be fully conversant with the installation and operating procedures. If in doubt, seek advice.

 **WARNING - Smoking** Do not smoke whilst working on the hydraulic system.

 **WARNING - Lifting** Always use the correctly rated shackle and lifting equipment. Refer to the table section 2.2, page 7 to ascertain product weight. Never use worn, damaged or undersized lifting equipment.

 **WARNING - Machine Operation** Always stop the machine and shut off the engine when leaving the machine. Never keep the machine running whilst installing or servicing the coupler.

 **WARNING - Maintenance Work** Maintenance work must only be done by competent personnel.

 **WARNING - Manual Handling** Take care when manually handling coupler & components, bucket and installation pins. Refer to the table section 2.2 page 7 to ascertain product weights.

 **CAUTION - Metal Splinters** Flying metal splinters can cause injury when driving metal pins in and out. Use a soft-faced hammer or drift to fit and remove metal pins. Always wear safety glasses.

 **WARNING - Safety Shutdown Procedure** Work of any type on machinery is always more dangerous when the machine is operating. Before cleaning, lubricating or servicing this unit, the following Safety Shutdown Procedure should **always** be followed:

- 1 Move the host machines propulsion control to the neutral position and idle the engine down.
- 2 Shut off the hydraulic fluid flow to the Coupler
- 3 Position the coupler so that it is completely resting on the ground
- 4 Engage the host machine's park brake
- 5 Move the host machine's throttle to slow idle, shut the engine off and remove the ignition key.

(2.1) IN CAB DECALS

A safety decal detailing the safe operation of the MPG quick coupler is supplied with the product. This must be fitted to the machine's cab where it can be clearly viewed by the operator.

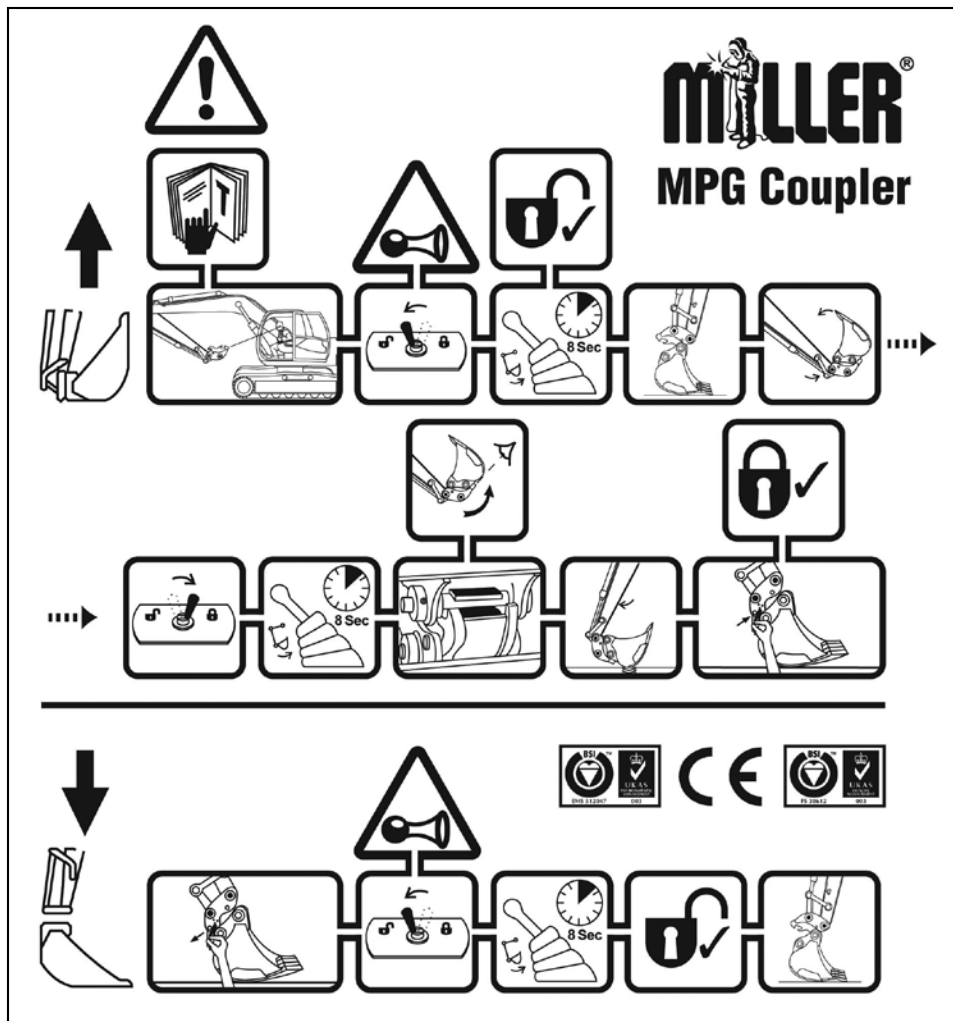

fig 2.0 MPG Coupler Decal

⚠ WARNING - Quick couplers extend the length of the dipper arm (fig 2.2) and with certain attachments could hit the cab in some positions (fig 2.3). Check this before operating the machine. If this is of concern ask your dealer for the Miller Scoop bucket (fig. 2.4).

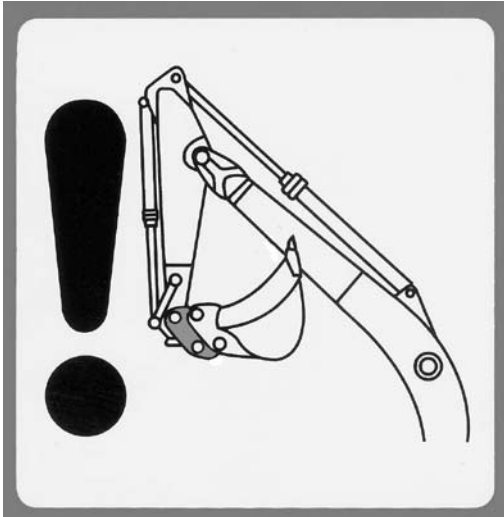

fig 2.2

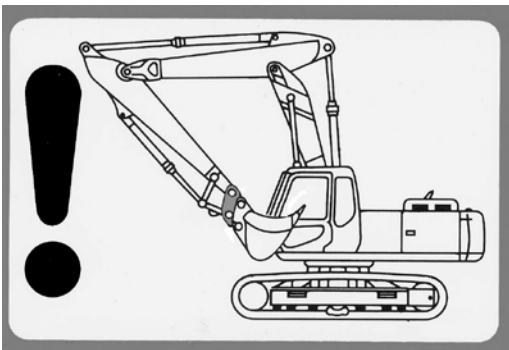

fig 2.3



fig 2.4
Miller Scoop Bucket and Miller Coupler

(2.2) BUCKET AND COUPLER PIN AND HYDRAULIC CYLINDER WEIGHT CHART

Machine tonnage range	Miller coupler range	Approx. coupler weight Kg	Approx. pin weight Kg	Approx. cylinder weight Kg
6 - 9	3	98	8.5	7
10 - 13	4	210	20	11
14 - 18	5	257	30	13
19 - 21	6	345	44	13
22 - 27	7	513	52	29
28 - 35	8	580	68	30
36 - 45	9	850	93	33
46 - 65	10	*	156	35
76 - 85	12	*	183	75

* The weight of range 10 - 12 couplers can vary significantly with model. Please refer to the coupler Data Plate, section 2.3, (fig 2.6).

(2.3) COUPLER IDENTIFICATION

To ascertain the serial number, weight and Safe Working Load (SWL) of the coupler please refer to the Data Plate (fig 2.6), detailed below. Alternatively find the serial number and SWL stamped into the coupler as shown below (fig 2.5).

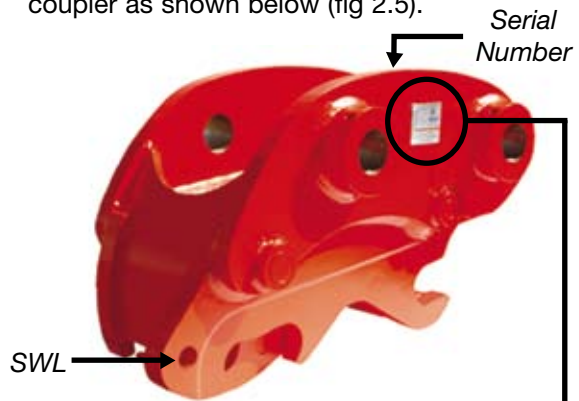

fig 2.5
Coupler Data Plate and stamp location



fig 2.6
Coupler Data Plate



Installation Guide and User Instructions
for Hydraulic Adjustable Quick Couplers

INSTALLATION

(3.0) PRE-INSTALLATION INFORMATION

SAFETY NOTE:

⚠ WARNING – Decals To ensure the safe operation of the quick coupler you must place the coupler decal in the machine cab where it can be seen clearly. Replace unreadable or missing decals with new ones before operating the machine.

⚠ WARNING – Protective Clothing Oil resistant safety gloves must be worn during installation/dismantling. Field Service personnel and operators must be fully conversant with the installation and operating procedures. If in doubt, seek advice.

⚠ WARNING – Smoking Do not smoke whilst working on the hydraulic system.

⚠ WARNING – Manual Handling Take care when manually handling coupler and components. Refer to the table in section 2.2, page 7 to ascertain product weight.

⚠ WARNING - Solenoid valves supplied may be 12 or 24 volts depending on machine; check you have the correct voltage solenoid valve before installation.

⚠ PRE INSTALLATION INFORMATION

- Each hydraulic coupler is supplied with the following:

- i) An electro hydraulic solenoid valve (12v or 24v)
- ii) Installation instructions (this book)
- iii) All required paperwork, certificates and decal

(3.1) INSTALLATION KIT

Check List of Parts Required

- 1 x Hydraulic coupler
- 1 x Operation attach/release switch
- 1 x Warning buzzer
- 1 x Short hose A (blue tag) with spring guard
- 1 x Short hose B (yellow tag) with spring guard
- 1 x Long hose A (blue tag)
- 1 x Long hose B (yellow tag)
- 1 x Hose P (red tag) hydraulic pump to solenoid
- 1 x Hose T (green tag) solenoid to hydraulic tank
- 2 x Hose joint fittings
- 6 x (approx) Weld on hose clamps (number required dictated by model of machine)
- 1 x cable ties (packet quantities)
- 1 x Safety Pin (MPG coupler only)

Note: All hydraulic hose specifications to 2 SN DIN – EN 853 (DIN 20022). All the hoses require the appropriate fittings to make the connection to the machine, depending on machine manufacturer.

Spare parts and hydraulic hose kits suitable for most excavators are available by contacting Miller or an authorised distributor. If in doubt, please ask.

Options which may be supplied are:

- i) Full installation kit and installation instructions (*fig 3.0*)
- ii) Dummy bucket and attachment pins, complete with locking bolts (*fig 3.1 & 3.2*)
- iii) Lifting shackles including test certificates (*fig 3.3*)

⚠ WARNING – Dummy Pins Do not use the dummy pins to fit the coupler directly to the machine. The dummy pins are only intended to be attached to the bucket or attachment. Use the machine's original OEM specification hardened pins to connect the coupler to the dipper arm and link.



fig 3.0



fig 3.1



fig 3.2



fig 3.3

(3.2) COUPLER INSTALLATION PROCEDURE

Step 1



fig 3.4

Remove plugs from cylinder ports

Step 4



fig 3.7

When both hydraulic hoses are fitted, the coupler should be positioned in such a way that the lifting eye is pointing away from the excavator.

Step 2



fig 3.5

Fit first hydraulic hose to coupler (cylinder port B – **yellow line**), and tighten to correct torque (15lb. ft or 20 Nm) (short hose with yellow tag and spring guard fitted).

Step 5



fig 3.8

Align the coupler with the end of the dipper arm and fit seals and shims where required. Lightly grease the O-ring seals and place over the edge of the coupler as shown.

Step 3



fig 3.6

Fit second hydraulic hose to coupler (cylinder port A – **blue line**) and tighten to correct torque (26lb.ft or 35Nm). This is the short hose with the blue tag and spring guard fitted.

Step 6



fig 3.9

Slowly lower the dipper arm into place while making sure the O-ring seals do not enter the pin bore or get damaged. Align the bores in the coupler with the bores in the dipper arm.

Step 8



fig 3.11

Slowly lower the link arm into place while making sure the O-ring seals do not enter the pin bore or get damaged. Align the bores in the coupler with the bores in the link arm as shown above.

Step 7



fig 3.10

Install the original OEM bucket pin through the coupler and dipper arm bores and fit the locking bolt and nuts. Fit shims if necessary.

⚠ WARNING: Use original OEM spec hardened pins to connect coupler to dipper/link. Use the supplied dummy pins for the bucket or attachment only. **Do not use dummy pins to fit the coupler to the machine.**

Step 9



fig 3.12

Align link arm then install the original OEM bucket pin through the coupler and link arm bores, fit the locking bolt and nuts (supplied). Fit shims if necessary.

Step 10



fig 3.13

Once both the OEM pins have been secured, place the coupler in a horizontal position. Straighten the hydraulic hoses, **removing any twist before fitting them** to machine dipper arm.

Step 11

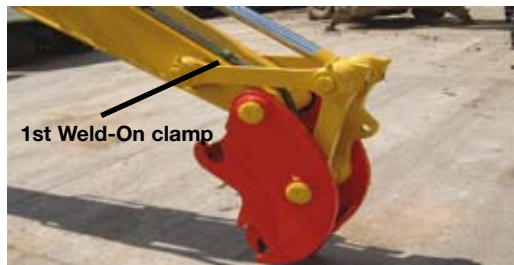

fig 3.14

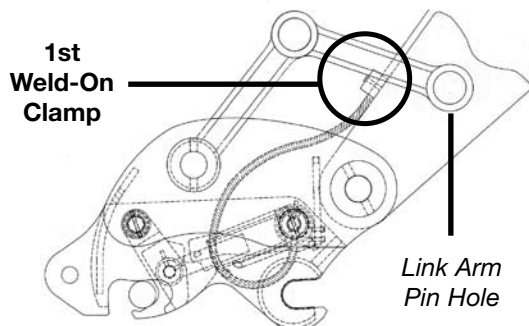

fig 3.15

Position the coupler into full crowd position and feed hydraulic hoses up through the coupler and onto the dipper arm. Connect 'long hose A' to 'short hose A' and 'long hose B' to 'short hose B' (fig 3.14). Fit 1st weld-on clamp approx 50 mm down from link arm pin hole (fig 3.15). Pull hoses to a snug fit and neatly straighten them ensuring spring guard is placed between the coupler cylinder and the first clamp. Shorten spring guard to required length (The spring guard is only fitted from the pipes to the cylinder to the first clamp). Tighten clamp to hold hoses in place. (20ib.ft/27Nm). Do not over tighten bends. The minimum bend radius should be 100mm.

Step 12



fig 3.16

The hose routing should be snug around the nose of the dipper as shown, but not too tight. The hoses should be free to move 10-20mm in either direction across the dipper arm.



fig 3.17



fig 3.18

If the hoses are not fitted correctly they can become entangled within the MPG coupler safety mechanism (fig 3.17) making it inoperative and unsafe.

Step 13



fig 3.19

Fit the remaining weld-on clamps up the dipper arm of the excavator at appropriately spaced intervals (approx. 450mm). Also ensure that hoses are flush and in line with the dipper arm to eliminate snagging. Follow the natural curve of the original excavator hydraulic hoses and steel pipes and clamp or cable tie where required up to the solenoid valve. Make sure that the hoses are not twisted.

Step 14



fig 3.20

Continue to fit hoses up the length of the dipper and tighten clamps. Ensure that all hoses are flush to the boom to prevent snagging during operation.

Step 15



fig 3.21

Shown above is a typical 'contact area' where hose guards should be fitted. Cable tie hydraulic hoses into position following the curve of the original hydraulic hoses.

Step 16



fig 3.22

Continue to fit hoses along the boom and clamp or cable tie into position where appropriate. This may vary with different machine makes.

Step 17 SOLENOID VALVE INSTALLATION

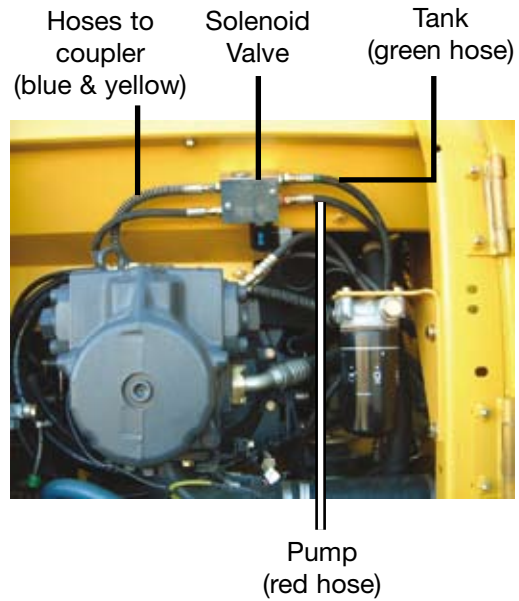

fig 3.23

Example only - location differs in other machine models

⚠ WARNING - Do not use low/servo pressure

Fit the solenoid valve in the vicinity of the pump compartment, in a safe and dry area near to the hydraulic pump. Locate 'take-off point' for **maximum** machine hydraulic pressure to supply to the solenoid valve, stamped **P**. Use either the pressure gauge test port or tap into the main pressure system between the pump and main control valve on the bucket cylinder circuit.

Make a connection into the tank for the return oil from the solenoid valve, stamped **T**. The tank and pressure fittings may not be supplied as they vary for different machine models. Connect up all hoses to solenoid valve, tank and pump. (Green, Red, Blue and Yellow hoses) (**maximum working pressure = 400 bar**).

Step 18

On/Off
Operating Switch



fig 3.24

Example of an OEM style
on/off operating switch.

(Switches differ with machine interior)



fig 3.25

Example of a Miller style on/off operating switch

Install the on/off operating switch inside the cab in a safe place for the operator to use.

Connect the electrical wiring. The live feed for the switch is taken from the ignition side. Connect the 12 volts DC or 24 volts DC power supply via a 5-amp fuse.

⚠ CAUTION - Do not connect a 12V solenoid to a 24V supply, or vice versa as damage to the solenoid will result.

⚠ CAUTION - Ensure the switch is installed in an area where it cannot be accidentally activated.

NOTE: The solenoid is energised when the switch is in the **release** or **off** position. In normal working conditions, the solenoid should be electrically disconnected and the switch in the **attach** or **on** position. The buzzer should only sound when the switch is in the **release** or **off** position. Install the buzzer inside the instrument console, in a safe convenient position and fasten securely.

You should now be ready to test the coupler and the hydraulic system.

Step 19

Power up machine engine revolutions to approximately quarter throttle and bottom out the bucket crowd link to put the hydraulics under pressure. Operate the switch to ensure the coupler cylinder is working correctly. This will give pressurised flow to the coupler cylinder and assist in the bleeding of the system. Repeat this procedure several times. After testing, check for leaks and rectify if necessary. If the system is free from leaks, the coupler should now be ready for use.

⚠ DANGER Hydraulic Fluid - Never use your hands to search for hydraulic fluid leaks, use a piece of paper or cardboard. Escaping fluid under pressure can be invisible and can penetrate the skin and cause serious injury. If affected, see a doctor at once.

(3.3) COUPLER REMOVAL



fig 3.26

Position the coupler so it is standing on the ground. Switch off the machine and operate the controls to vent residual pressure in the hydraulic system. Unscrew the short hoses from the long hoses and 'blank off' the ends of the long hoses using blanking plugs.

To remove the couplers follow the installation procedure in reverse order starting at Step 9 page 11.

(3.4) ELECTRICAL & HOSE INSTALLATION DIAGRAMS

Please turn to the inside back cover for a full colour version of these diagrams.

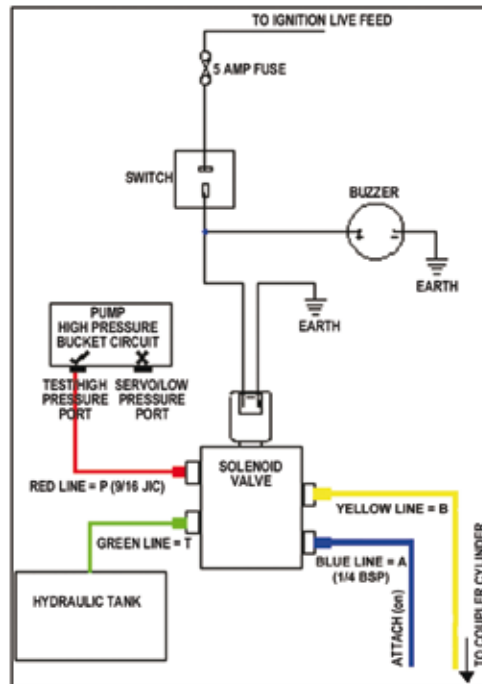
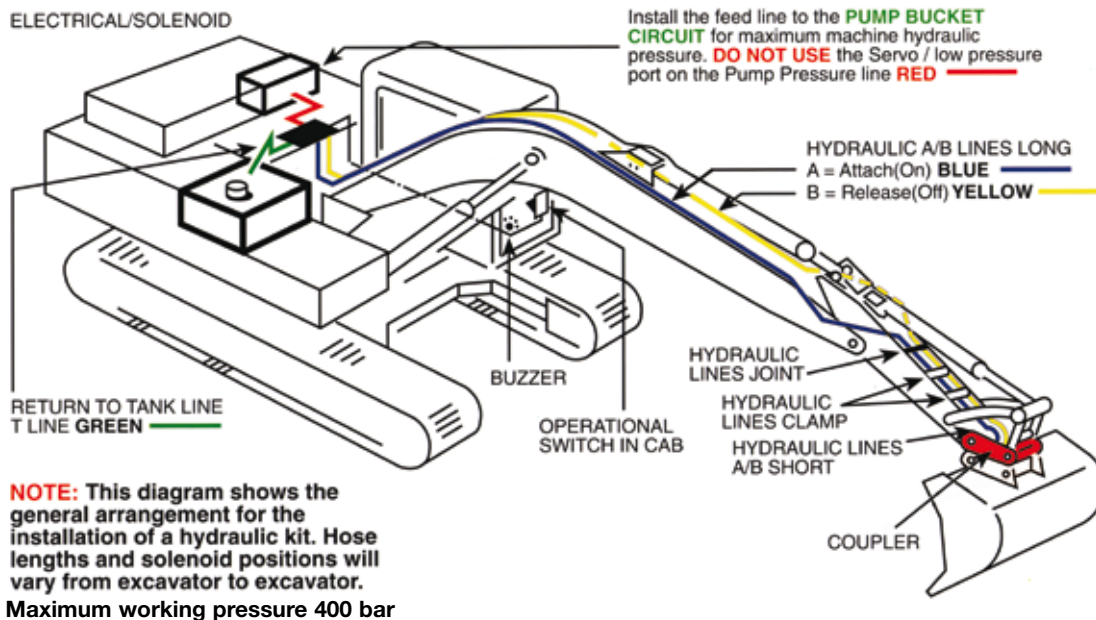

fig 3.27
Solenoid & Hose Arrangement



NOTE: This diagram shows the general arrangement for the installation of a hydraulic kit. Hose lengths and solenoid positions will vary from excavator to excavator. Maximum working pressure 400 bar

fig 3.28
Hydraulic Hose Installation



Installation Guide and User Instructions
for Hydraulic Adjustable Quick Couplers

OPERATION

(4.0) MPG COUPLER OPERATION - TO ATTACH

⚠ WARNING - Never place your hands inside the coupler, or attempt to make adjustments or repairs while the hydraulic system is pressurised. Never switch to the **release** or **off** position while the coupler is in use. Never use the front or back of the hydraulic hook/jaw as a lifting device.

⚠ WARNING - The operator should be familiar with the correct use of the coupler before operation.

⚠ WARNING - Place the coupler decal in the machine cab where it can be seen clearly. Replace unreadable ones with new ones before operating the machine.

⚠ WARNING - The operator must ensure that all steps of the MPG coupler operation attachment procedure, found on these pages and also on the in-cab decal, are followed in the correct order. Failure to do so may result in the bucket or attachment being inadvertently released due to incorrect operation.

⚠ WARNING - Buckets/attachments must **NEVER** be lifted or moved without **BOTH** bucket/attachment pins being **FULLY ENGAGED**. Failure to do so will result in bucket/attachment release and could result in serious injury or fatality.

⚠ WARNING - Never operate the MPG Coupler without the safety pin in place.

Step 1



fig 4.19

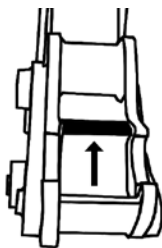

fig 4.20

Ensure the coupler safety pin is removed. Place coupler in the curled/crowded position. Turn the coupler switch to the **release** or **off** position - the buzzer will sound. Hold the bucket crowd lever for approx. 5-10 seconds to allow the hook to fully retract. Visually inspect to check the hook is fully retracted (fig 4.19 & 4.20).

Step 2



fig 4.21

Ensure that the hook is fully retracted before attempting to engage the bucket/attachment. Place the coupler above the bucket /attachment.

Step 3



fig 4.22

Curl the coupler to engage the bucket pins.

Step 4



fig 4.23

Continue to curl the coupler until the bucket is lifted off the ground.

Step 5

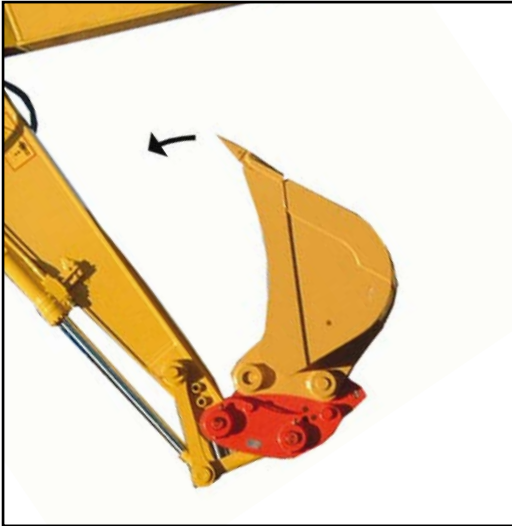

fig 4.24

Fully curl/crowd the bucket. Switch to the **attach** or **on** position, the buzzer will cease. Hold the bucket crowd lever for approx. 5-10 seconds to allow the hook to fully engage and clamp the bucket pin (fig 4.24).

Below figures 4.25 and 4.26 show the hook fully engaged and clamping the bucket pin.

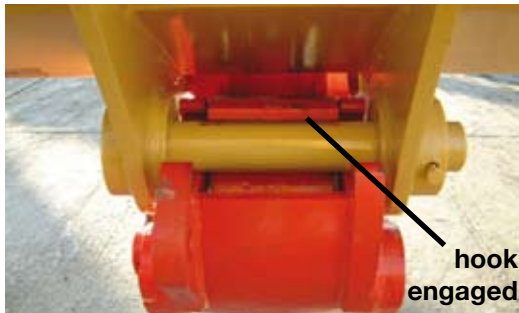

fig 4.25

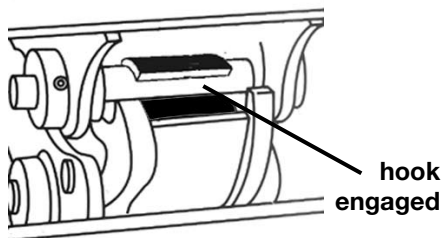

fig 4.26

⚠ DANGER - If the bucket/attachment pins have not been correctly engaged the hook **MUST NOT** be retracted. This could force the bucket/attachment to be unintentionally released from the coupler and could result in machine damage or personal injury. Please refer to step 8 for remedial action.

Step 6



fig 4.27

Visually inspect and check that the hook is engaged.

Step 7



fig 4.28

If it is not possible to view this from the cab then the operator must get out of the cab and stand in a safe place to visually inspect before operating the machine.

Step 8



fig 4.29

To ensure that the bucket/attachment pins are securely held by the coupler, apply pressure to the bucket/attachment by rotating it against the ground and away from the machine before operating.

Step 9

If the hook is correctly engaged then the coupler is ready for operation. If it is not correctly engaged then place the bucket/attachment on the ground and release the bucket/attachment then repeat steps 1 – 8.

Step 10



fig 4.29



fig 4.30

If the hook is correctly engaged the manual back up safety pin must be inserted (fig 4.29).

The safety pin must be fitted by hand pressure only, not hammered or forced into position. Once the safety pin is in place, insert the lynch pin into the end of the safety pin to secure it (fig 4.30)

⚠ WARNING – The MPG Coupler frame is a multi-hole design, in some cases the safety pin will fit freely into more than one hole. If this occurs use the hole closest to the hook without forcing the safety pin into position. The safety pin must be fitted by hand pressure only, not hammered or forced into position.

MPG COUPLER OPERATION - TO RELEASE

Step 1



fig 4.31

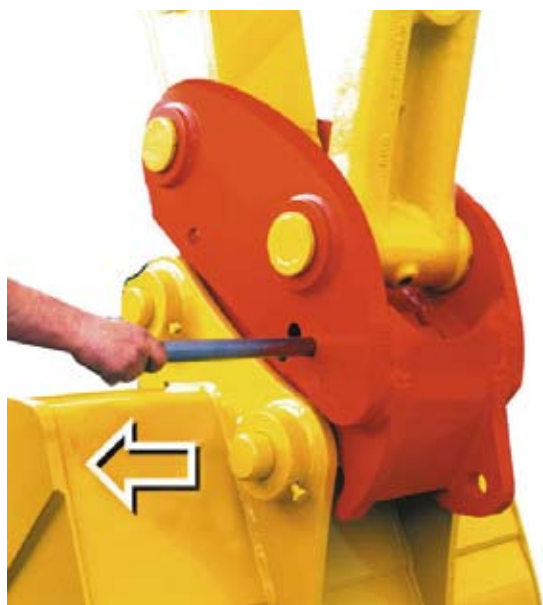

fig 4.32

Place the bucket/attachment on the ground and remove the lynch pin (fig 4.31) and the safety pin (fig 4.32)

⚠ WARNING - Do not release or change the bucket near any persons or in any areas that may result in an accident or injury occurring. The switch should be in the **attach** or **on** position at all times, except during attachment or bucket changing only.

Step 2



fig 4.33

Turn the coupler switch to the **release** or **off** position - the buzzer will sound. Hold the bucket crowd lever for approx. 5-10 seconds to allow the hook to fully retract.

Step 3



fig 4.34

Once the hook is fully retracted slowly curl the coupler to a horizontal position to release the rear bucket pin.

Step 4



fig 4.35

Lift the dipper arm until the coupler has disengaged the front bucket pin. The coupler is now safely disengaged.

(4.1) LIFTING WITH THE MPG COUPLER

⚠ WARNING - Lifting Always use the correctly rated shackle and lifting equipment. Refer to the table section 2.2, page 7 to ascertain product weight. Never use worn, damaged or undersized lifting equipment.

The coupler has an integral and certified lifting eye, the Safe Working Load of which can be found stamped into the coupler frame (next to the lifting eye). Do not lift over the SWL limit of the coupler. The lifting capability of the machine should also be checked prior to lifting. Lift with the coupler in a vertical position (fig 4.36).

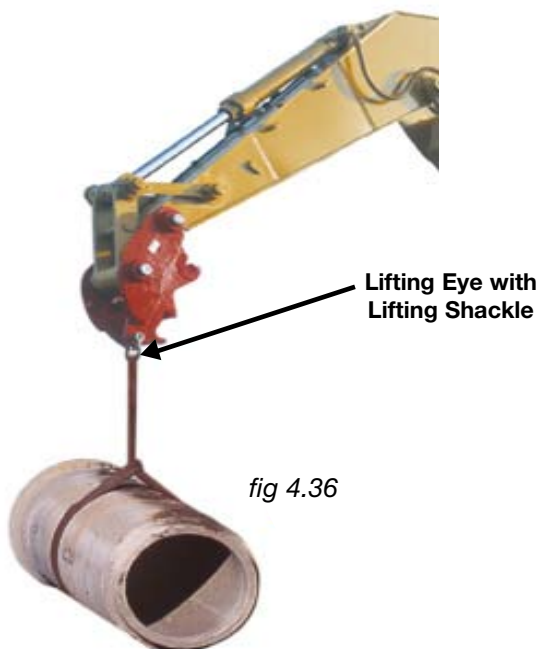

(4.2) USING DEMOLITION ATTACHMENTS & WORK TOOLS

Miller Couplers are able to work with hydraulic breakers, various attachments, and work tools, depending on pin spread and weight.

⚠ CAUTION - Do not use any tool that is not in the correct tonnage class i.e. that is larger than that specified by the machine manufacturers. When operating a breaker you must always use it in the vertical position when ever possible. Never use the breaker as a lever. If using other attachments, the same procedure applies.

⚠ WARNING - If the coupler is fitted with a hydraulic breaker it should not be used for long periods without a periodic inspection of all working parts. If the hydraulic breaker has to be used continuously for long periods of time Miller recommend the coupler should be removed and the breaker should be mounted directly to the machine.



fig 4.37



fig 4.38

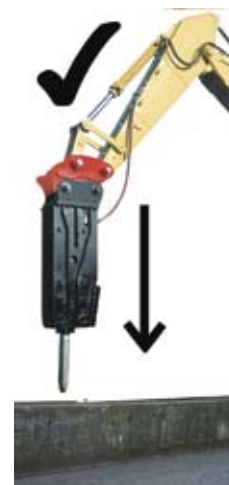

fig 4.39

(4.3) INCORRECT COUPLER USE

The following information highlights some of the operating bad practices that occur in the field. **Miller UK strongly advises against these practices and recommends that the coupler should only be used as per the operating instructions.**



INCORRECT USE OF COUPLER TO PICK UP AND MOVE ATTACHMENTS

1. Moving attachments by front pin only



2. Using hook only to lift attachments



3. Picking up product before the hook is retracted



4. Nipping or jamming the rear pin with the hook



USING THE JAW AS A LIFTING TOOL OR HAMMER

1. Moving product held in the jaw

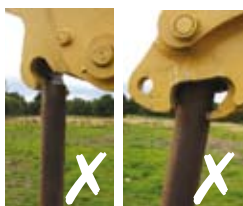

2. Using jaw to hammer products into the ground



USING THE HOOK TO LIFT AND MANOEUVRE PRODUCT

1. Moving product using the hook



2. Positioning product gripped with hook



INCORRECT USE OF COUPLER TO PICK UP PRODUCTS USING CHAINS OR SLINGS

1. Using the jaw to pick up products with chains.



2. Using the corner of the jaw to pick up products with chains.



3. Using the hook to pick up products with chains.



4. Using the coupler body to pick up products with chains.



5. Using the dipper arm to pick up products with chains.



6. Using the cylinder to pick up products with chains.

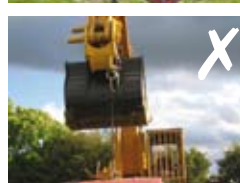

INCORRECT USE OF THE LIFTING EYE

1. When the bucket is still attached it is not possible to see the shackle and what is happening to the chain



2. Close up of the above.



Installation Guide and User Instructions
for Hydraulic Adjustable Quick Couplers

MAINTENANCE

(5.0) MPG GENERAL MAINTENANCE



WARNING - Maintenance Work

Maintenance work must only be done by competent personnel or ask Miller to assist.



DANGER - Hydraulic Fluid

Never use your hands to search for hydraulic fluid leaks, use a piece of paper or cardboard. Escaping fluid under pressure can be invisible and can penetrate the skin and cause serious injury. If affected, see a doctor at once.



WARNING - Coupler Condition

A defective coupler could injure you or others. **Do not** operate a coupler that is defective.

Maintenance and Service

To ensure that your quick coupler works safely and to maximum efficiency it is imperative that it is properly maintained in accordance with the following service guidelines.

Replacement Parts

We recommend that you fit genuine replacement parts. You will need to quote the **coupler serial number** stamped on the coupler data plate.

1. Carry out all daily checks
2. Lubrication points - Ensure that all grease points are greased regularly (at least once a week minimum). If damaged, replace and grease. It is important to follow the lubrication instructions in sequence i to v so that none of the grease nipples are overlooked.
 - i. Uncouple the bucket/attachment. (Refer to the operation instructions- section 4 page 21).
 - ii. Retract the coupler cylinder. Switch off the engine.
 - iii. Apply grease via nipple **A** to the piston end of the cylinder.
 - iv. Apply grease via nipple **B** to the hook
 - v. Apply grease via nipple **C** to the rod eye.

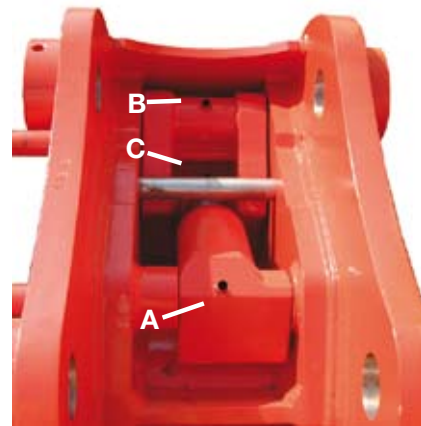

fig 5.1

(5.1) MPG DAILY CHECKS

1. Thoroughly clean the coupler
2. Check the coupler for cracked, bent or broken components, distressed welds, missing parts and oil leaks. Replace broken parts if required.
3. Ensure that the safety pin is not bent and shows no signs of wear including the pin holes.
4. Check the security of the mounting pins, locking bolts and nuts.
5. Check the condition of the hydraulic hoses, fittings and hydraulic system generally. Replace any that are damaged.

(5.2) MPG WEEKLY CHECKS

It is recommended that the following procedures are carried out at least once per week.

(5.3) MPG SAFETY PIN CHECK

The following safety check is to be carried out to ensure that the safety pin is working correctly and is holding the bucket/attachment in position as it would in the event of a hydraulic failure. This check should be carried out after coupler installation and after any maintenance has been carried out. **Please note: Do not use excessive force during these tests.**

MPG - Safety Check

After fitting the safety pin, switch to the off position. The hook will retract and the bucket/attachment will become slack, but should not be released. If it is possible to release the bucket/attachment, select a different hole position and re-test. If you are still able to release the bucket/attachment **do not operate**. Seek advice under these conditions. If you cannot release the bucket/attachment then re-engage the hook by switching to **attach** or **on** and work as normal.

(5.4) TORQUE SPECIFICATIONS

The torque specifications are as follows:

Securing bolts for spring (Bug)	30lb.ft	40Nm (Fit Thread locking adhesive)
Check valve	30lb.ft	40Nm
B hose connection male (cylinder hose)	15lb.ft	20Nm
A hose connection male (cylinder hose)	26lb.ft	35Nm
Pressure hose connection female	20lb.ft	27Nm
Tank return hose connection female	55lb.ft	75Nm
Weld on block	20lb.ft	27Nm
Solenoid Valve		
A Line filter fitting ¼ BSP M/M Adapter	25lb.ft	34Nm
B Line filter fitting 7/16 JIC x 7/16 UNF	15lb.ft	20Nm
P Line 9/16 JIC x 9/16 UNF	26lb.ft	35Nm
T Line 3/8 BSP M/M Adapter	55lb.ft	75Nm
Spool Valve	40.6lb.ft	54.2Nm
Check Valve	33.8lb.ft	40.6Nm
Electro-magnetic lock nut	5.4lb.ft	8.1Nm
Plug	9.3lb.ft	13Nm

(5.5) TROUBLE SHOOTER GUIDE



DANGER - Hydraulic Fluid

Never use your hands to search for hydraulic fluid leaks, use a piece of paper or cardboard. Escaping fluid under pressure can be invisible and can penetrate the skin and cause serious injury. If affected, see a doctor at once.



WARNING - Ensure the bucket attachment or work tool is placed on the ground before carrying out any of the following activities.



WARNING - Always vent the hydraulic tank before working on the coupler.



WARNING - Ensure that all personnel are clear of the coupler before carrying out any of the checks.

If the coupler begins to work erratically or fails to work, check the following:

GENERAL - Check:

1. Snapped, bent or lost pins.
2. Hydraulic leaks
3. Hose leaks, wear or damage to hoses.
4. Damaged or bent cylinder.
5. Loose or broken nuts and bolts

ELECTRICAL - Check:

1. The in line fuse to the cab switch has not blown.
2. The magnetic coil on the solenoid valve has not become loose or burnt out through vibration.
3. That no electrical wires are broken
4. That the switch and/or buzzer is not broken
5. That the voltage to the magnetic coil is correct (24 volts main line feed, to a 24 volt system).
6. Electrical wiring. (fig 3.26 Page 14)

HYDRAULIC - Check:



WARNING - Always remove the electrical supply to the switch before commencing work on the hydraulics (Remove machine key and disconnect battery).

Contamination - The most common cause of coupler failure is contaminated hydraulic oil (dirty oil or rubber hose particles in the system, caused by incorrect installation of hose lines). If this occurs, the coupler may work slowly, release/attach erratically, or lock **on** or **off**. In this situation the following procedure needs to be applied:

1. Check the solenoid valve block assembly for contamination as follows:
 - i. Switch off the machine and operate the controls to vent residual pressure in the hydraulic system
 - ii. Vent pressure from the hydraulic tank by releasing the hydraulic tank filler cap.
 - iii. Remove the solenoid valve and dismantle and inspect it for blockages or damaged seals
 - iv. Clean and replace all seals if necessary.
 - v. Clean or change filter fittings.
 - vi. Re-assemble solenoid unit and install to the machine. If in doubt, change solenoid valve unit.

2. Re-connect up all hydraulic hoses to correct ports as detailed in the installation procedure. Ensure the pressure feed hose connects to the port marked **P** and the tank return hose connects to the port marked **T** (fig 3.26 Page 14)

3. Check that the coupler hydraulic cylinder has not 'locked on' due to contamination as follows:

- i. switching the coupler to the release position and disengage the machine hydraulics.
- ii. When the cylinder is fully retracted, switch off the machine and operate the controls to vent residual pressure in the hydraulic system.



WARNING - Care must be taken whilst unscrewing the check valve as there may be some residual pressure in the hydraulic cylinder. Unscrew the valve slowly to allow any trapped pressure to escape.

- iii. Slowly unscrew the check valve in the hydraulic cylinder.
- iv. Inspect the check valve, clean or replace the O-ring seals.
- v. Clean all cavities including the cylinder
- vi. Reassemble the check valve into the cylinder.
- vii. If there is any damage to the cylinder replace the complete unit including the check valve.

OPERATION - Check:

If the coupler is switched to the **attach** or **on** position but the bucket can be powered off, then the cylinder or the cylinder check valve is losing hydraulic pressure and may need re-sealing or replacing. To check for loss of pressure, place the bucket on the ground and attempt to move the coupler on the bucket. If the coupler does not hold firmly, this means the coupler is losing hydraulic pressure due to a failed cylinder or check valve.



WARNING Do not operate the coupler in this condition. Have repairs carried out immediately.

(5.6) MPG COUPLER COMPONENT LISTS

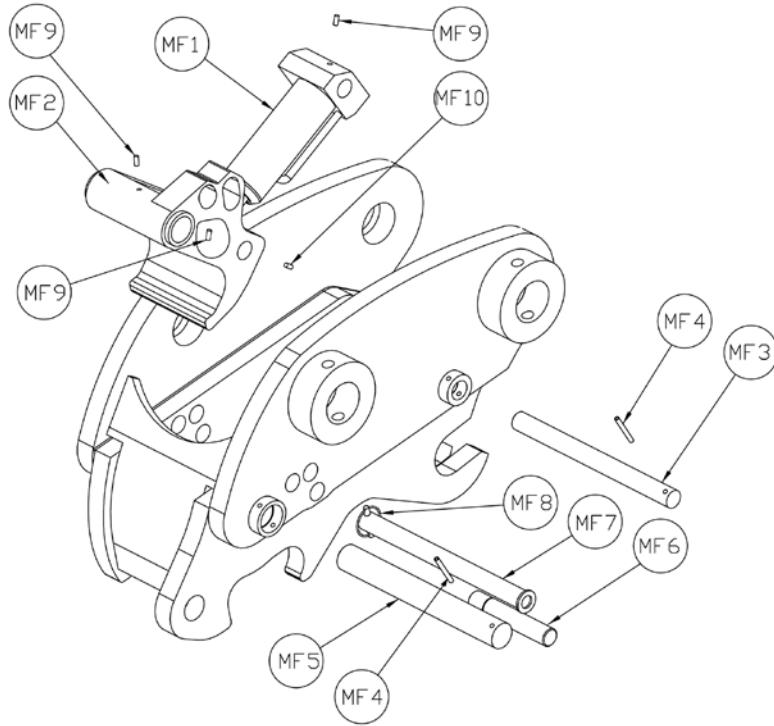

Parts Reference Guide

- MF1. Cylinder
- MF2. Hook
- MF3. Cylinder Pin
- MF4. Roll Pin x 2
- MF5. Hook Pin
- MF6. Cylinder Hook Pin
- MF7. Safety Pin
- MF8. Lynch Pin
- MF9. Grease Nipple x 3
- MF10. Grub Screw

*fig 5.10
Fabricated MPG Coupler Components*

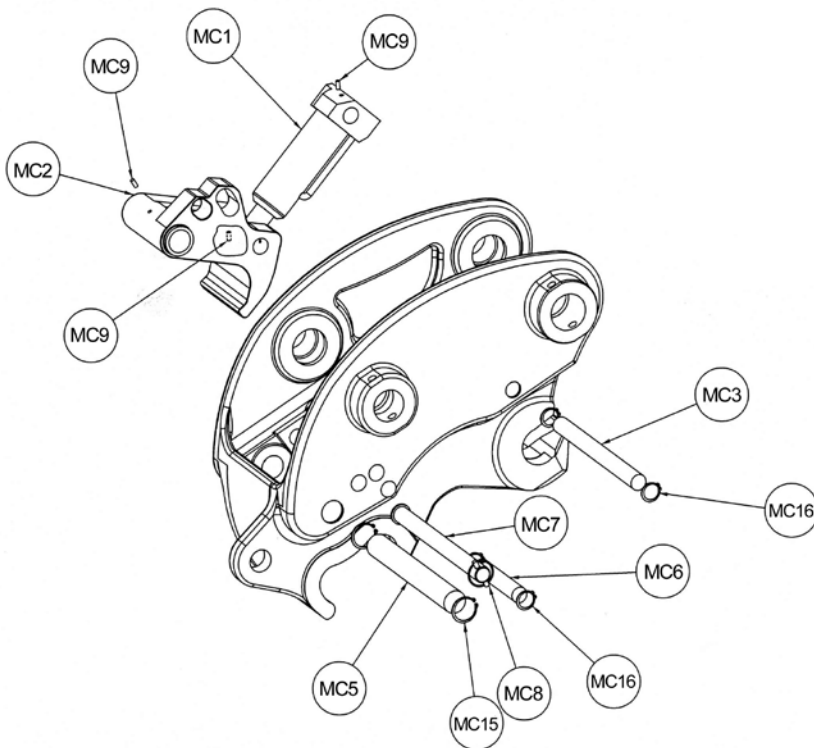

Parts Reference Guide

- MC1. Cylinder
- MC2. Hook
- MC3. Cylinder Pin
- MC4. n/a
- MC5. Hook Pin
- MC6. Cylinder Hook Pin
- MC7. Safety Pin
- MC8. Lynch Pin
- MC9. Grease Nipple x 3
- MC10. n/a
- MC11. n/a
- MC12. n/a
- MC13. n/a
- MC14. n/a
- MC15. Circlip x 2 (Hook Pin)
- MC16. Circlip x 2 (Cylinder Hook Pin)
- MC17. Circlip x 2 (Cylinder Pin)

*fig 5.11
Cast MPG Coupler Components*

Miller reserves the right to amend detail or specification without prior notification.

(5.7) MPG HYDRAULIC CYLINDER REMOVAL AND REPLACEMENT

⚠ WARNING - Please make sure you **do not contaminate** any hydraulic fittings on replacement procedure

Removal

1. Uncouple the bucket/attachment/work tool from the coupler. (Refer to the Operation - Section 4 page 22).
2. Lock the hook by moving the coupler switch to the lock/on position.
3. Remove the coupler from the machine. (Refer to Coupler Removal - Section 3.3, page 14).
4. Refer to Coupler Component lists on page 32 to identify the parts detailed in the removal procedure below.



fig 5.12

5. **Fabricated Coupler** - Remove the grub screw (**MF10**) positioned on the underside/rear face of the hook. **Cast Coupler** - Remove the circlips (**MC16**) from the coupler body.



fig 5.13

6. Remove the cylinder hook pin (**MF6** or **MC6**).



fig 5.14

7. Remove the roll pin securing the cylinder pin (**MF4**) or circlip (**MC17**) securing the cylinder pin (**MF3** or **MC3**).



fig 5.15

8. Remove the cylinder pin (**MF3** or **MC3**).



fig 5.16

9. Remove the hydraulic cylinder (**MF1** or **MC1**).



fig 5.17

10. Remove hydraulic hoses A + B from the cylinder.

Hook and cylinder Removal

On some couplers the small cylinder pin (**MF6** or **MC6**) is inaccessible because of the coupler frame. To change this remove the long hook pin (**MF5** or **MC5**) and lift out the hook and cylinder as one assembly then remove the small cylinder pin.

Procedure for Replacement

Replacement is the reverse of the removal procedure.

(5.8) INSTRUCTIONS FOR INSPECTION AND REPAIR OF COUPLER FRAME

If the coupler frame becomes worn or damaged in the area of the side plate rear jaw see *fig 5.18*, then the following procedure must be followed for repair.

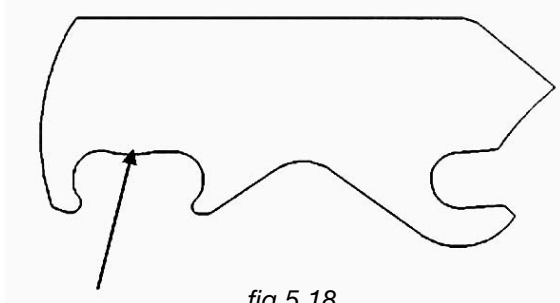

The maximum wear allowed around this area is 5mm. If the wear is more than this then repairs must be carried out.

1. Contact Miller for a template for the coupler quoting serial number and coupler type.
2. The area affected should be prepared with use of a grinder before being built up with weld to match the appropriate shape. Mig welding is recommended for these repairs. Alternatively, welding with low hydrogen electrodes (E7018 or equivalent) can be used. All welds should be blended in and smooth to avoid stress areas.
3. Once fully welded the repaired areas must be allowed to cool slowly.
4. Fully dress the welded areas by grinding and check to ensure that they do not interfere with the movement of the hook or other parts of the coupler. Check that the dressed areas match that of the template provided.
5. Clean off all sharp edges and repaint the coupler. Carry out a maintenance check (sections 5.0 to 5.6) before refitting the coupler to the machine.



Installation Guide and User Instructions
for Hydraulic Adjustable Quick Couplers

WARRANTY

(6.0) WARRANTY

Warranty Period

The warranty period is twelve (12) months from date of delivery to the first user, or eighteen (18) months from date of shipment ex-works MILLER, whichever is the sooner.

Limitation of Liability

Miller shall not be liable for or in respect of:

1. Repair or replacement of **(i)** any normal wearing parts, **(ii)** any ageing or deterioration caused by foreign substances or by exposure to the natural elements or **(iii)** any consumable items, such as oil, grease, filters etc.
2. Any cost of repairs, alterations or replacements made without official Miller authorisation.
3. Any warranted product which has been subjected to:-
 - (a)** Misuse, improper operation or misapplication, including but not limited to operation beyond the rated capacity expressly prohibited by the manufacturer of the prime moving machine, as shown in the operator's manual or rated capacity charts furnished with the prime moving machine.
 - (b)** Neglect, including but not limited to **(i)** improper maintenance and storage, **(ii)** use of the product while any parts are loose, broken or out of order.
 - (c)** Accident.
 - (d)** Improper or unauthorised installation, adjustment, repair or alteration, including but not limited to **(i)** adjustment or assembly procedures, not recommended or authorised in the User Guide manual. **(ii)** use of unauthorised parts or attachments, **(iii)** unauthorised modification or alteration.

Miller shall be liable only for repair or replacement of parts as described under 'warranty coverage', and Miller shall not be liable, whether under breach of warranty, negligence or strict liability, for any other injury, loss, damage or expenses, whether direct or consequential, including but not limited to loss of use, income, profit or production, increased cost of operation, or spoilage of or damage to material.

Alterations

Miller reserves the right to make alterations or modifications to their products and literature at any time, which in their opinion may improve the performance and efficiency of the product. Miller shall not be obliged to make such alterations or modifications to products already in service.

The foregoing warranty is exclusively and in lieu of all other warranties, including warranties concerning merchantability or fitness for a particular purpose, which are expressly disclaimed, whether written, oral, express or implied.

Miller assumes no other obligations or responsibility with respect to the products whatsoever, and no employee or representative is authorized to change or extend this warranty in any way or grant any other warranty whatsoever.

If in doubt please contact Miller for free advice and assistance, please find contact details on back cover.

ELECTRICAL & HOSE INSTALLATION DIAGRAMS

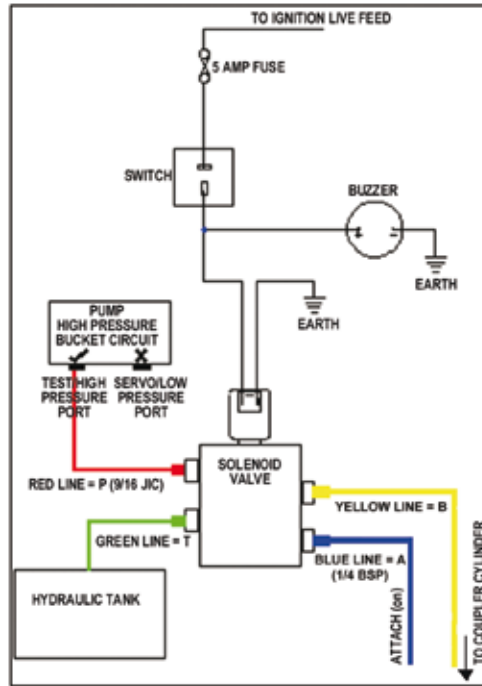

fig 3.27
Solenoid & Hose Arrangement

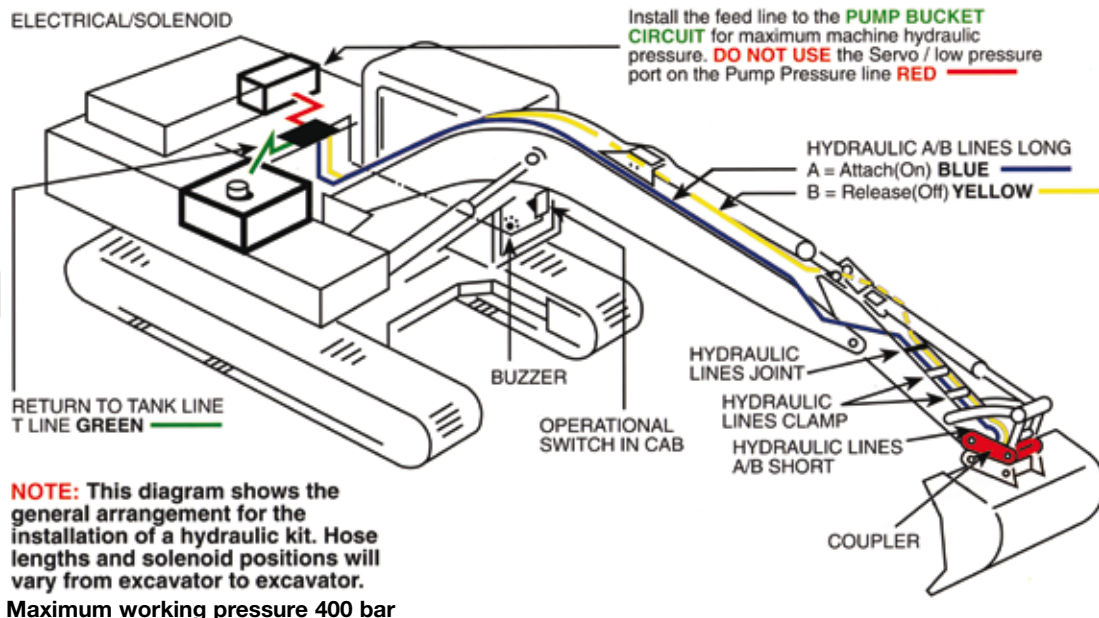

fig 3.28
Hydraulic Hose Installation

CONTACT MILLER

Telephone: +44 (0) 1670 707 272

Fax: +44 (0) 1670 707 474

E-mail: Info@millers-uk.com

Web: www.millersdirect.com